

GERMAN POOL 德國寶

專業 高效 空氣 清新 機 | PUF-70

High-Performance Air Purifier

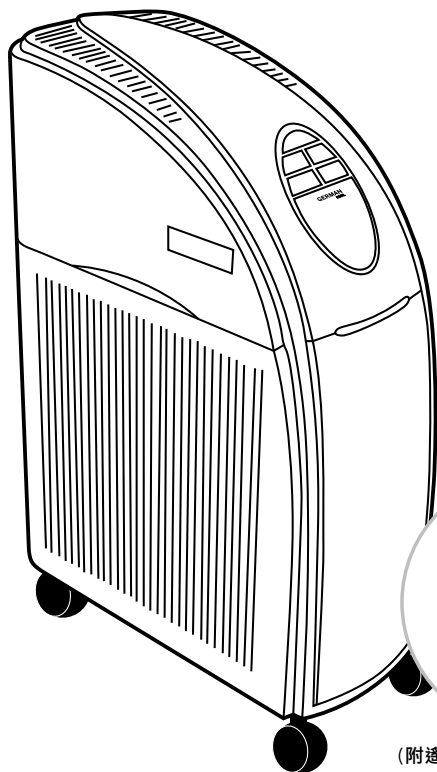

(附遙控器 With Remote Control)

在使用之前請詳細閱讀「使用說明書」及「保用條例」，並妥為保存。
Please read these instructions and warranty information carefully before use and keep them handy for future reference.



使用說明書 OPERATING INSTRUCTIONS

目錄 Table of Contents

注意事項 Notice Before Use 03

產品結構 Product Structure 04

操作說明 Operating Instructions 07

清潔與保養 Care & Maintenance 10

常見故障及處理 Troubleshooting 12

技術規格 Technical Specifications 13

保用條款 Warranty Terms & Conditions 15

注意事項 Notice Before Use

重要說明

為安全起見，初次使用產品前請先細閱本說明書，並保存說明書，以便作參考之用。

本產品只供家居使用。請必須依照本說明書內的指示安裝及操作。

1. 在使用本產品前，請確認產品所標明的使用電壓，是否與接地插座電壓一致，並切勿與其他電器共用電源插頭。
2. 使用本產品時，電源插頭必須完全插入插座，否則會容易造成觸電或因過熱而引起火災；請勿使用殘缺或鬆動的插座。
3. 啟動本產品前確保濾網蓋已蓋好，以免影響正常運作。
4. 本產品須放在堅固和穩定的平面上使用。
5. 切勿於本產品運作時將手指或外物伸入進出風口。
6. 請勿坐在或站在本產品上面。
7. 請勿阻礙進出風口，以免影響淨化效果。
8. 拔除插頭時，切勿接觸到金屬部分或用力過度。
9. 請勿將本產品泡在水中或對機身澆水，以免引起短路或觸電。
10. 電源線和插頭不可用水或其他液體清洗或浸泡，插頭不可用濕布擦拭，手部潮濕時請勿插入或拔出插頭，以免引起觸電。
11. 請勿將本機靠近熱源或在機身下方放置抹布，以免造成散熱不良。
12. 切勿使用任何酸性或鹼性溶液清洗機器，以防觸電或損傷。
13. 移動本機、清潔或更換過濾網前，必須先切斷電源。
14. 本產品並不適宜讓兒童、身體或心智殘障、缺乏經驗或知識的人士操作，除非該人士得到負責保護其安全的人士之監督或指引。
15. 切勿將包裝材料（塑料袋、卡紙、發泡膠等）放在兒童可觸及的地方，以免發生危險。
16. 兒童必須被監督，切勿讓兒童使用、觸摸或把玩本產品。
17. 如電源線損壞或發生其他故障，切勿自行拆卸、修理或改裝，必須由本公司或合資格的專業技術人員更換和維修。

Important

For safety purpose, you should read the instructions carefully before using the appliance for the first time. Save the instructions for future reference.

The appliance is designed for domestic use and may only be installed and operated in accordance with these instructions for use.

1. Before plugging in the appliance, check that the electrical rating shown on the rating plate corresponds with your house electricity supply.
2. Plug the appliance to the wall outlet properly and securely to avoid electric shock or a fire caused by overheat.
3. Make sure the filter cover is completely closed before using the appliance in order to ensure proper operation.
4. Do not use the appliance on an inclined surface.
5. Do not insert fingers or objects into the grille when the appliance is in operation.
6. Do not sit or stand on the appliance.
7. Do not block the grille in order to deliver the best air purification.
8. Do not touch the metal part of the plug when unplugging or unplug with force.
9. Never immerse the appliance in water or splash water onto the appliance to avoid risk of short circuit or electric shock.
10. Never immerse the power cord or plug in water or other liquids for cleaning. Do not wipe the plug with wet towels or plug or unplug with wet hands.
11. Do not place the appliance near a source of heat. To ensure proper cooling, do not place cloth under the appliance.
12. Never clean the appliance with any acidic or alkaline liquids to avoid electric shock or appliance damage.
13. Unplug the appliance before moving or cleaning it and before filter replacement.
14. The appliance is not intended for use by persons, including children, with reduced physical, sensory or mental capabilities, or any individual lacking experience and knowledge unless they have been given supervision or instruction by a person responsible for their safety.
15. Keep all packing materials, such as plastic bags, cartons and styrofoam, out of reach of children in order to avoid danger.
16. Children should be under supervision to ensure that they do not play with the appliance.
17. If the power cord is damaged, it must be replaced by the manufacturer, its service agent or similarly qualified persons in order to avoid a hazard. Do not attempt to disassemble, repair or modify the appliance.

產品結構 Product Structure

機身

Body

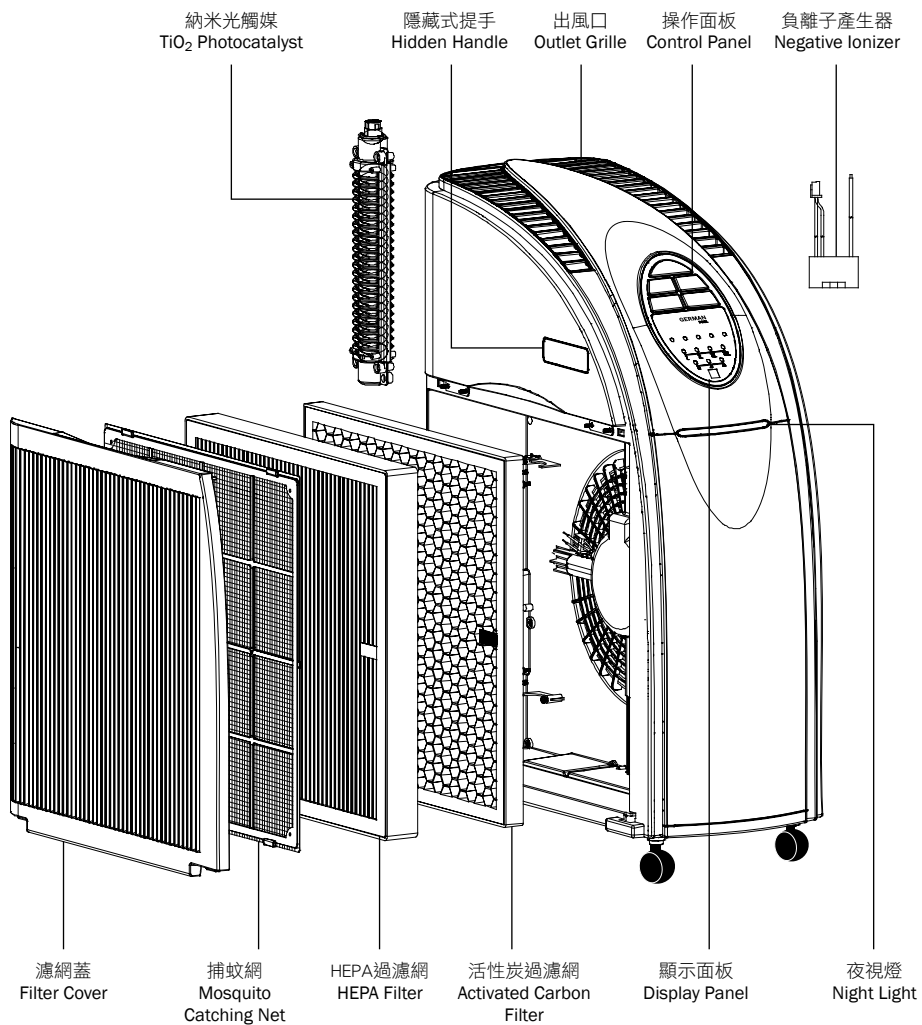

產品結構 Product Structure

操作面板

Control Panel

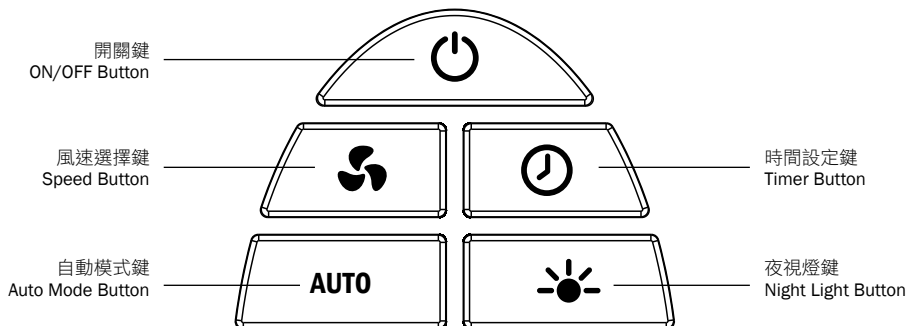

顯示面板

Display Panel

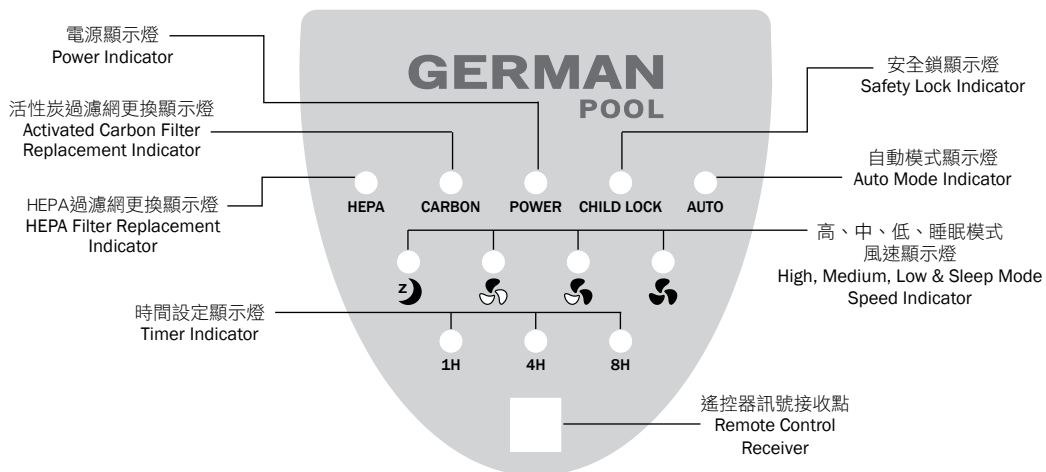

產品結構 Product Structure

配件

Accessories

1. 紅外線遙控器：

此空氣清新機配備紅外線遙控器。

1. Infra-red Remote Control :

This air purifier is equipped with an infra-red remote control.

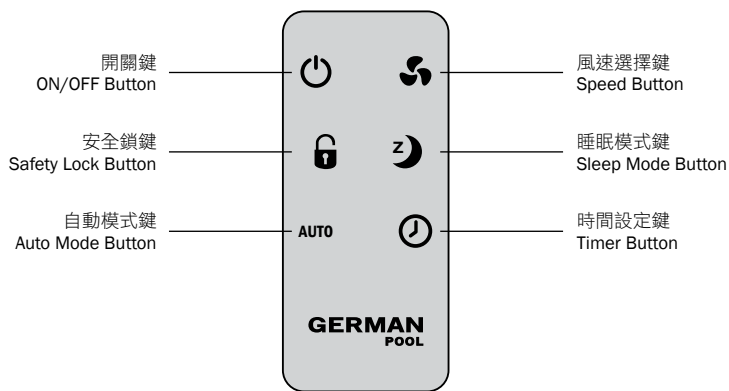

2. 腳輪一套(共四個)

2. Wheel Set (4 pcs)

操作說明 Operating Instructions

注意：

- 查看插座電壓是否與本機相符。
- 在正式啟動前，重複練習拆裝本機數次。
- 使用本機時切勿打開任何濾蓋，否則電源會自動切斷以保障安全。
- 在清洗或拆裝前必須先拔掉電源。
- 切勿將機器浸泡於任何液體中。
- 切勿把手指或任何物放入出風口，以免造成危險或損壞機件。
- 啟動前先拆開過濾網包裝。

1. 操作面板

開關鍵

- 接通電源後，空氣清新機會處於待機模式，輕按此鍵會自動設定以低檔運作，並發出訊號音，從出風口吹出已過濾的空氣。
- 再按一下此鍵即可關機。

風速選擇鍵

- 風速設四檔，即睡眠、低速、中速及高速。
- 開機後自動設定以低檔運作，每按一下檔位依次提高一檔，顯示面板中的風速顯示燈亦同時依次改變，每次更改設定會發出訊號音。
- 風速選擇功能按此循環運作：
低速檔→中速檔→高速檔→睡眠模式。

自動模式鍵 AUTO

- 開機後按此鍵以啟動自動模式，顯示面板中的自動模式顯示燈亦會亮起。
- 啟動此功能會以高速檔運行兩小時，再以中速檔運行2小時，再以低速檔運行2小時。
- 自動模式功能按此循環運作：高速檔→中速檔→低速檔。

時間設定

- 時間設定功能設四檔，即連續、1H、4H及8H。
- 開機後自動設定以連續模式運轉(於顯示面板中不會有任何顯示)。每按此鍵一下依次前進一檔，顯示面板中的時間設定顯示燈亦同時依次改變，每次更改設定清新機會發出聲響。
- 時間設定功能按此循環運作：
連續→1H→4H→8H。

夜視燈鍵

- 按一下即啟動夜視燈功能，再按一下可關掉此功能。

Attention:

- Check that if the electrical rating of this appliance corresponds with the socket.
- Repeat installation steps as practice before using the appliance.
- Do not open any filter cover during operation or else the appliance will cut off the power automatically for safety purpose.
- Unplug the appliance before cleaning or disassembling.
- Do not immerse the appliance or components in any liquid.
- Do not insert fingers or objects into the inlet or outlet grille in order to avoid danger or appliance damage.
- Unpack filters before use.

1. Control Panel

ON/ OFF Button

- The appliance will be at stand-by mode after connecting with power. Press ON/ OFF Button and it will automatically set to operate at low speed with an indicative sound. Purified air will come out from the outlet grille.
- Press ON/ OFF Button again to turn off the appliance.

Speed Button

- There are 4 speed settings, which are: Sleep, Low Speed, Medium Speed and High Speed
- The appliance automatically sets to operate at Low Speed after connecting with power. Press Speed Button to increase the speed and it gives a sound after each setting change. The Speed Indicator on display panel also changes accordingly.
- The speed setting follows the cycle of Low Speed Mode→Medium Speed Mode→High Speed Mode→Sleep Mode.

Auto Mode Button AUTO

- Activate the auto mode by pressing Auto Mode Button. The Auto Mode Indicator on the display panel will also be on.
- After activating auto mode, the appliance will first operate at high speed for 2 hours, which will be followed by operation at medium speed for another 2 hours, and then low speed for another 2 hours.
- The auto mode follows the cycle of High Speed Mode→Medium Speed Mode→Low Speed Mode.

Timer Button

- There are four timer settings, which are Continuous Mode, 1H, 4H and 8H.
- The appliance automatically sets at Continuous Mode after connecting with electricity (without indication on the display panel). Press Timer Button to set the timer and it gives an indicative sound after each setting change. The Timer Indicator on the display panel also changes accordingly.
- The timer setting follows the cycle of Continuous Mode→1H→4H→8H.

Night Light Button

- Press this button to activate the night light function and press this button again to inactivate it.

操作說明 Operating Instructions

2. 遙控器

除夜視燈功能外，上述各項功能可透過遙控器操作，而遙控器亦另設以下2個功能按鍵。

睡眠模式鍵

- 輕按此鍵即啟動睡眠模式，清新機會自動設定以最低速運作。

安全鎖鍵

- 輕按此鍵，遙控器及空氣清新機上的所有按鍵均停止操控，但機件仍根據之前設定的模式運作。
- 解鎖方法：長按安全鎖3秒即自動解除。

3. 顯示面板顯示燈

HEPA過濾網指示燈

- HEPA過濾網顯示燈亮起時，代表HEPA過濾網需要更換。

註：

HEPA過濾網需要更換時，此顯示燈會閃動，更換後此顯示燈仍會閃動，須長按風速選擇鍵3秒以停止閃動及重新設定空氣清新機。

活性炭過濾網指示燈

- 此顯示燈亮起時，代表需要更換活性炭過濾網。

註：

活性炭過濾網需要更換時，此顯示燈會閃動，更換後此顯示燈仍會閃動，須長按風速選擇鍵3秒以停止閃動及重新設定空氣清新機。

電源顯示燈

- 接通電源時此燈會亮起。

時間設定顯示燈

1H 代表運作1小時後自動關機

4H 代表運作4小時後自動關機

8H 代表運作8小時後自動關機

安全鎖顯示燈

- 啟動安全鎖功能時此顯示燈會亮起。

2. Remote Control

All functions except night light could be activated with the remote control, on which there are 2 more functions as described below.

Sleep Mode Button

- Activate Sleep Mode by pressing this button and the air purifier will automatically set to operate at the lowest speed.

Safety Lock Button

- All buttons on the appliance and the remote control cannot function after pressing this button while the appliance will still be in operation according to the settings set previously.
- Press the Safety Lock Button and hold for 3 seconds for automatic unlock.

3. Display Panel Indicators

HEPA Filter Replacement Indicator

- This light will be on when the HEPA filter needs to be replaced.

Note:

This indicator will flash if the HEPA filter needs to be replaced. It will not stop flashing after filter replacement. Press the Speed Button and hold for 3 seconds to stop the flashing and to reset the air purifier.

Activated Carbon Filter Replacement Indicator

- This light will be on when activated carbon filter needs to be replaced

Note:

This indicator will flash if the activated carbon filter needs to be replaced. It will not stop flashing after filter replacement. Press the Speed Button and hold for 3 seconds to stop the flashing and to reset the air purifier.

Power Indicator

- The light will be on when the appliance is connected with power.

Timer Indicator

1H Turn off automatically after operating for 1 hour

4H Turn off automatically after operating for 4 hours

8H Turn off automatically after operating for 8 hours

Safety Lock Indicator

- This light will be on when Safety Lock function is activated.

操作說明 Operation Instructions

自動模式顯示燈 **AUTO**

- 此燈亮起時代表已啟動自動模式。

Auto Mode Indicator **AUTO**

- Auto mode is activated when this light is on.

風速顯示燈

☾ 睡眠模式 ⚙️ 低速檔 ⚙️ 中速檔 ⚙️ 高速檔

Speed Indicator

☾ Sleep Mode ⚙️ Low Speed Mode
⚙️ Medium Speed Mode ⚙️ High Speed Mode

遙控器訊號接收點

註：

使用遙控器時須與此接收點保持在5米之內，並確保兩者之間沒有障礙物。

Remote Control Receiver

Note:

Keep the distance between the remote control and the remote control receiver within 5 metres and make sure there is no obstacle in between.

4. 淨化組件

- 捕蚊網
- 納米光觸媒
- 負離子產生器
- HEPA過濾網
- 活性炭過濾網

4. Purification Components

- Mosquito Catching Net
- TiO₂ Photocatalyst
- Negative Ionizer
- HEPA filter
- Activated carbon filter.

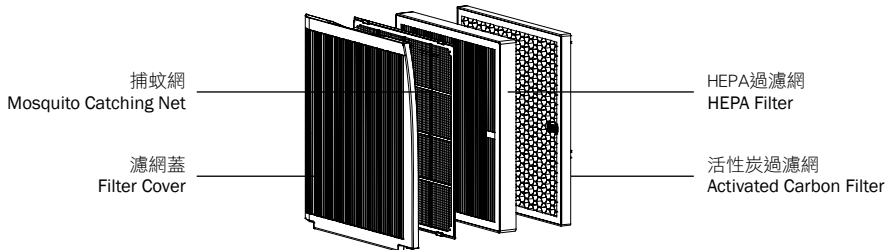

清潔與保養 Care & Maintenance

警告

- 為免觸電，在清潔與維修前必須關掉本機，並拔除電源插頭。
- 切勿將機件浸泡於任何液體中。

Caution

- In order to avoid electric shock, please turn off the appliance before cleaning or repair.
- Do not immerse the components in any liquid.

1. 只可於清洗或更換過濾網時才可打開濾網蓋。
2. 打開濾網蓋時，清新機會即時切斷電源以保障安全，此時才可開始清洗或更換過濾網。
3. 清理或更換過濾網後必須裝回濾網蓋，機器才能正常運作。
4. 過濾網使用約8個月須作更換(以每日使用中檔風速8小時計算)。
5. 捕蚊網可用清水沖洗及毛刷清洗。
6. HEPA過濾網及活性炭過濾網則只能用吸塵機清洗，切勿使用清水沖洗，以免影響空氣淨化效果。
7. 請使用軟毛刷清洗濾網組件及進出風口，切勿用漂白劑及塑料製的百潔布。
8. 只能用柔軟乾布擦洗機身表面。

1. Open the filter cover only when the filter needs to be cleaned or replaced.
2. The air purifier will immediately cut off the power for safety reason once the filter cover is opened. Only until then could the filters be cleaned or replaced.
3. Install the filter cover after cleaning or replacing the filters; otherwise the appliance cannot operate.
4. The filters are suggested to be replaced every 8 months (assuming the appliance operates at medium speed for 8 hours per day).
5. The mosquito catching net can only be cleaned with water and a brush.
6. HEPA filter and activated carbon filter can only be cleaned with vacuum cleaners. Do not clean these filters with water in order to deliver the best air purification effect.
7. Clean the purification components and outlet grille with soft brush. Do not clean with bleach or plastic sponge cloth.
8. Only clean the air purifier surface with a soft and dry cloth.

清潔與保養 Care & Maintenance

捕蚊網清洗方法

請依以下步驟清洗捕蚊網，以保持最佳效果。



1. 關機後用手指扣在濾網蓋中間凹陷的圓角處，用力把濾網蓋往外拉出。
Turn off the appliance. Pull the round top middle part of the filter cover and take out the filter cover gently.



3. 先用毛刷刷掉灰塵及毛髮，然後用水清洗。
Remove the dust and hair on the net with a brush and wash the net with water.



5. 先插好濾網蓋下面的兩個凸腳，然後往內把濾網蓋推回原位。
Insert the protruding corners of the filter cover into the air purifier and push the cover back to its original position.

Instructions of mosquito catching net cleaning

Please follow these steps to clean the mosquito catching net.

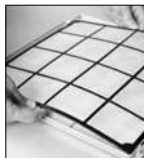

2. 用手指捏住捕蚊網中間的兩個手指位，往上抽起捕蚊網。
Hold the 2 finger positions in the middle and pull the net out.

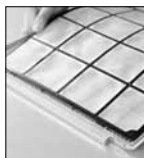

4. 先將捕蚊網一邊的兩個凸腳插到濾網蓋內，然後再把另外一邊的凸腳插到濾網蓋內。
Insert one of the protruding corners of the net into the filter cover and then insert another one.

過濾網更換方法

請依以下步驟更換過濾網，以保持最佳空氣淨化效果。



1. 關機後用手指扣在濾網蓋中間凹陷的圓角處，用力把濾網蓋往外拉出。
Turn off the appliance. Pull the round top middle part of the filter cover and take out the filter cover gently.



3. 放入新的過濾網，HEPA過濾網須(即白色面)須向外然後裝回捕蚊網。
Replace with new filters with the HEPA filter (the white one) facing outward. After that, put the mosquito catching net to its original position.



5. 兩個過濾網更換顯示燈於更換過濾網後仍會閃動，須長按操作面板或遙控器上的風速選擇鍵3秒，以停止閃動及重新設定空氣清新機。
The 2 filter replacement Indicators will not stop flashing after filter replacement. After replacing the filter, press the Speed Button, either on control panel or on the remote control, and hold for 3 seconds in order to stop the flashing and to reset the air purifier.

Instructions of filter replacement

Please follow these steps to replace the filter in order to keep the best air purification effect.



2. 用手指捏住過濾網的白絲帶往外拉，取出複合過濾網。
After removing the mosquito catching net, pull the white strip with fingers and take out the filters.



4. 先插好濾網蓋下面的兩個凸腳，然後把濾網蓋往內推以裝回原位。
Insert the protruding corners of the filter cover into the air purifier and push the cover back to its original position.

常見故障及處理 Troubleshooting

使用中如發現本機操作上有問題，請依照下表進行檢查。

When you run into any problems when operating this appliance, use the table below to troubleshoot the problems.

故障現象 Phenomenon	原因分析 Possible Cause	處理方法 Solution
機器不運轉。 The unit does not operate.	電源線是否有正常連接好? Whether the power cord has been disconnected?	將插頭和插座連接好。 Connect the power cord to the outlet.
	連接插頭是否鬆脫或斷路? Whether the plug is loose or there is short circuit?	正確連接或更換插頭。 Connect properly or replace the plug.
	濾網蓋安裝是否妥當? Whether the filter cover is installed properly?	裝好濾網蓋。 Install the filter cover properly.
出風口有異味。 Smell comes from the grille.	過濾網是否吸附太多異味或煙塵? Whether the filter has too much smell or dust on it?	更換濾網。 Replace the filter.
	過濾網是否已使用太久需要更換? Whether the filter has been used too long and needs to be replaced?	更換濾網。 Replace the filter.
淨化效果不理想。 The purification effect is not satisfactory.	室內空氣是否過於乾燥? Whether the indoor air is too dry?	適當增加室內空氣濕度。 Raise the humidity of the indoor air accordingly.
	機器放置在不通風的地方或機器附近有障礙物? Whether the air purifier is put in a place with bad ventilation or there is any obstacle around?	改變擺放位置或移走障礙物。 Move the air purifier to another place or remove the obstacle(s).
沒有空氣吹出。 No purified air coming out.	有異物堵塞進出風口? Whether there is any object blocking the inlet or outlet?	清除異物。 Remove the objects.
遙控器無效。 Remote control does not work.	是否已安裝電池? Whether a battery is installed?	安裝電池。 Install a battery.
	電池是否反轉? Whether the battery is installed upside down?	正確安裝電池。 Install the battery properly.
	電池是否無電? Whether the battery has run out?	更換新電池。 Replace with a new battery.
	遙控器的距離與角度是否超出範圍? Whether the distance and angle exceeds the applicable area of the remote control?	與遙控器訊號接收點之間的距離保持於5米內。 Keep the distance between the remote control and the remote control receiver within 5 metres.

注意：如問題持續發生，請關機及拔除電源插頭，並送回本公司維修。

Note: If the problem persists or other abnormal situations occur, turn off and unplug the air purifier, and return it to our Repair Centre for repair.

技術規格 Technical Specifications

型號 Model	PUF-70
電壓 Voltage	230 V
頻率 Frequency	50 Hz
功率 Power	70 W
適用面積 Applicable Coverage Area	20 - 40 m ²
風速設定 Speed Setting	睡眠模式、低、中、高 Sleep Mode, Low, Medium, High
時間設定 Timer Setting	連續模式、1H、4H、8H Continuous Mode, 1H, 4H, 8H
機身尺寸 Dimensions	(H) 648 mm (W) 220 mm (D) 458 mm
淨重 Net Weight	8.0 kg

產品規格及設計如有變更，恕不另行通知。

Specifications are subject to change without prior notice.

中英文版本如有出入，一概以中文版為準。

If there is any inconsistency or ambiguity between the English version and the Chinese version, the Chinese version shall prevail.

如欲獲取更多有關本產品最新資訊，歡迎瀏覽本公司網站。
For additional product information, please visit our website.

www.germanpool.com

請填妥以下空格並與發票一併保存，以便維修時核對資料。用戶提供本公司之所有資料必須正確無誤，否則免費保用將會無效。
Please fill out the form below. This information and the purchase invoice will be required for any repairs. Warranty will be invalid if information provided is found to be inaccurate.

型號 Model No. : PUF-70

機身號碼 Serial No. : _____

發票號碼 Invoice No. : _____

購買商號 Purchased From : _____

購買日期 Purchase Date : _____

保用條款

此保用提供德國寶產品之機件在正常使用下壹年保用(自購買日起計算)。

* 貴戶須在購機十天內，以下列其中一種方式向本公司登記資料，保用手續方正式生效：

- 1) 填妥本公司網頁內之保用登記表格 www.germanpool.com/warranty。
- 2) 填妥保用登記卡，並連同購機發票之副本一併郵寄到客戶服務部 (本公司將不發還發票副本或登記卡)。

1. 未能出示購買發票正本者，將不獲免費維修服務。
2. 用戶應依照說明書的指示操作。本保用並不包括：
 - 上門安裝、檢驗、維修或更換零件之人工以及一切運輸費用；
 - 因天然與人為意外造成的損壞 (包括運輸及其他)；
 - 電源接合不當、不依說明書而錯誤或疏忽使用本機所引致之損壞。
3. 於下列情況下，用戶之保用資格將被取消：
 - 購買發票有任何非認可之刪改；
 - 產品被用作商業或工業用途；
 - 產品經非認可之技術人員改裝或加裝任何配件；
 - 機身編號被擅自塗改、破壞或刪除。
4. 總代理有權選擇維修或更換配件或其損壞部份。
5. 產品一經被轉讓，其保用即被視作無效。

維修部 - 小型電器

德國寶(香港)有限公司
香港九龍紅磡暢通道 1 號
中旅貨運物流中心8樓
電話：+852 2215 4582
傳真：+852 2356 9798
電郵：repairs@germanpool.com

Warranty Terms & Conditions

Under normal operations, the product will receive a 1-year full warranty provided by German Pool (effective starting from the date of purchase).

* This warranty is not valid until Customer's registration information is returned to and received by our Service Centre within 10 days of purchase via one of the following methods:

- 1) Visit our website and register online: www.germanpool.com/warranty.
- 2) Complete all fields on the attached Warranty Card and mail it back to our Customer Service Centre along with a photocopy of the purchase invoice (Warranty Card and invoice copy will not be returned to Customer).

1. Customer who fails to present original purchase invoice will be disqualified for free warranty.
2. Customer should always follow the operating instructions. This warranty does not apply to:
 - labour costs for on-site installation, check-up, repair, replacement of parts and other transportation costs;
 - damages caused by accidents of any kind (including transport and others);
 - operating failures resulted from incorrect voltage, improper operations and unauthorized installations or repairs.
3. This warranty is invalid if:
 - purchase invoice is modified by unauthorized party;
 - product is used for any commercial or industrial applications;
 - product is repaired or modified by unauthorized personnel, or unauthorized parts are installed;
 - serial number is modified, damaged or removed from the product.
4. German Pool will, in its discretion, repair or replace any defective part.
5. This warranty will be void if there is any transfer of ownership from the original purchaser.

Repair Centre - Small Appliances

German Pool (Hong Kong) Limited
8/F, China Travel (Cargo) Logistics Centre
1 Cheong Tung Road
Hung Hom, Kowloon, Hong Kong
Tel : +852 2215 4582
Fax : +852 2356 9798
Email : repairs@germanpool.com

此保用只適用於香港

This warranty is valid only in Hong Kong

GERMAN
POOL



德國寶

德國寶(香港)有限公司 German Pool (Hong Kong) Limited

香港總代理 Hong Kong Sole Agent

九龍土瓜灣馬頭角道116號新寶工商中心高層地下2-4號室
Room 2-4, Upper G/F, Newport Centre, 116 Ma Tau Kok Road,
Tokwawan, Kowloon

電話 Tel: +852 2333 6245 傳真 Fax: +852 2765 8215

中國總代理 China Sole Agent

廣東省佛山市順德區南國東路永旺(吉之島)購物中心3樓
3/F, Yongwang (Jusco) Shopping Mall, Nanguo East Road,
Shunde, Foshan, Guangdong

電話 Tel: +86 757 2980 8308 傳真 Fax: +86 757 2980 8318



© 版權所有。未獲德國寶授權，不得翻印、複製或使用本說明書作任何商業用途，違者必究。

© All rights reserved. Copying, reproducing or using the contents of this manual is not allowed without prior authorization from German Pool, violators will be prosecuted.

www.germanpool.com